

LED Area and Site Luminaire

Project:

Location:

Catalog #:

Quantity:

Features

Teslyte SB-QL Series is a high performance LED luminaire with superior thermal management, highly efficient LED technologies and quality driver providing years of reliable operation. The SB-QL series is an excellent choice to illuminate any large areas.

- Housing:
 - Corrosion resistant die-cast aluminum body
 - Integral heat sink and driver compartment
 - UV stabilized powder coat finish over a Chromate Conversion Coating
 - Photocell adaptable
- Lens
 - Clear Tempered Flat Glass Lens
 - Clear Tempered Prismatic Flat Glass Lens
- Highly efficient Cree LEDs and quality driver
- Applications: Any large areas such as industrial locations, urban roadways, parking lots, schools and universities
- Mounting: Pole height of 16 to 35 feet; direct to square pole, adjustable slip-fitter, 2-3/8" diameter mounting arm adapter, yoke or two-piece bracket
- Warranty:
 - 5 years warranty UL listed,
 - IP65 Rated, suitable for wet locations

Ordering Information

Product code	Voltage	Distribution	Wattage	CCT (K)	Finish	Optional
SB-QL45	- <input type="text"/>	- <input type="text"/>	- <input type="text"/>	- <input type="text"/>	- <input type="text"/>	- <input type="text" value="XXY*"/>
	U- Univ. (100 -277Vac) 1- 347-480Vac	3- Type III 5- Type V	167- 167W 256- 256W	30- 3000K 40- 4000K 50- 5000K	BR- Dark Bronze C- Custom (consult factory)	XX- Mounting Y- Photocell

* Optional: **CF-** Direct mount to square pole; **SF-** Slip-fitter; **MA-** Mounting Arm Adaptor; **YK-** Yoke; **SB-** 2 piece swivel bracket
P- Photocell control (110-277 VAC Instant Twist Lock Photocell)

Note: Fixtures must be grounded in accordance with national, state, and/or local electrical codes. Failure to do so may result in serious personal injury

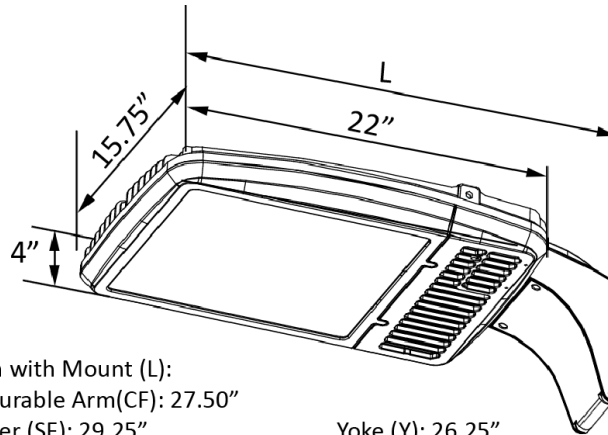
Mechanical Dimensions

Length with Mount (L):
 Configurable Arm(CF): 27.50"
 Slipfitter (SF): 29.25"
 Mounting Arm Adaptor (MA): 26.13"
 Yoke (Y): 26.25"
 Bracket (BR): 25.75"

Mounting Options

Configurable Arm (CF)
 Die Cast Configurable Arm. Mounts Directly to Square Poles, Includes Hardware.



Pole Mounting Arm Adaptor (MA)
 Die Cast Adaptor for 2 3/8" Horizontal Mounting Arms, Includes Hardware.



Yoke (YK)
 Stamped Heavy-Duty Steel Yoke, Includes Hardware.





External Slipfitter Mount (SF)
 External Die Cast Adjustable Slipfitter for 2 3/8" Tenons, Includes Hardware.





2-Piece Swivel Bracket (SB)
 2-Piece Stamped Steel Adjustable Bracket, Includes Hardware.

Effective Projected Area

Configuration	EPA (Sq. Ft.)	Weight (Lbs.)
 1	1.00	33 Lbs

Configuration	EPA (Sq. Ft.)	Weight (Lbs.)
 2@180° Mount	2.00	66 Lbs
 2@90° Mount	1.36	66 Lbs

Configuration	EPA (Sq. Ft.)	Weight (Lbs.)
 3@90° Mount	2.20	
 3@120° Mount	2.00	

Configuration	EPA (Sq. Ft.)	Weight (Lbs.)
 4@90° Mount		

**Shown with Configurable Arm (CF)*

Photometric Performance

Wattage	Drive Current (mA)	Input Wattage	Optics	5000K (80 CRI)		4000K (80 CRI)	
				Lumens	LPW	Lumens	LPW
167W	525	177	Type III	21,820	122	20,347	114
			Type V	20,814	116	19,409	109
256W	525	281	Type III	33,449	122	31,191	114
			Type V	31,907	116	29,753	108